

FEATURES AND SPECIFICATIONS

Features and Benefits

- 6 circuit standard
- Molded latches lock on header
- Polarizing ribs
- Keying options
- Friction lock

Reference Information

Product Specification: PS-90331
 Packaging: Bag
 UL File No.: E29179
 CSA File No.: LR19980
 Mates With: [8619](#)
 Designed In: Millimeters

Electrical

Voltage: 250V
 Current: 4.0A
 Contact Resistance: 20mΩ max.
 Insulation Resistance: 500 MΩ min.

Mechanical

Contact Insertion Force: 336g max.
 Contact Retention to Housing: 14g min.
 Wire Pull-Out Force: 36N min.
 Durability: 25 cycles

Physical

Housing: Natural polyester, UL 94V-0
 Contact: Copper Alloy
 Plating: Tin
 Operating Temperature: -40 to +85°C
 Wire Range: 18 to 24 AWG
 Insulation Diameter: 2.79mm (.110") max.



3.96mm (.156") Pitch Industry Standard Power Supply Crimp Terminal and Housing

8993/90331

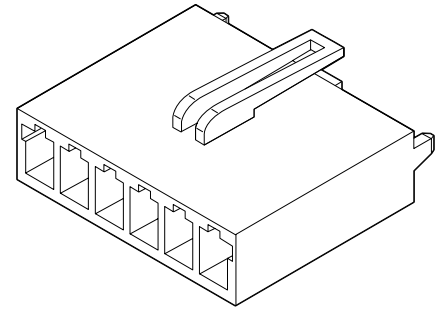

CATALOG DRAWING (FOR REFERENCE ONLY)

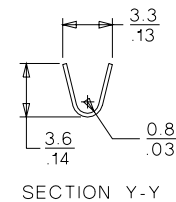
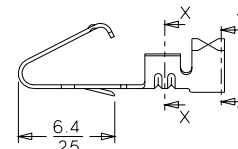
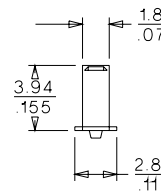
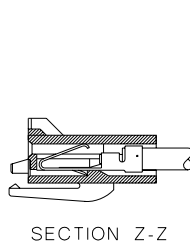
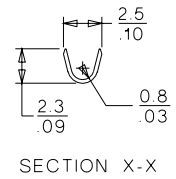
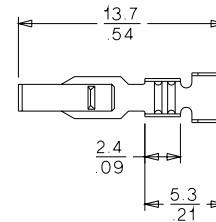
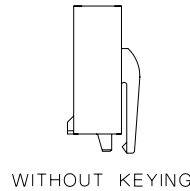
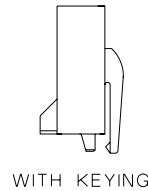
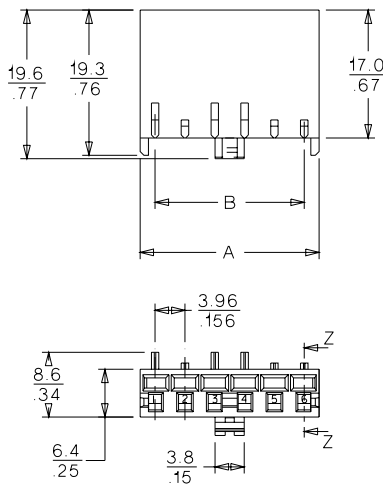

ORDERING INFORMATION AND DIMENSIONS

Circuit No.	Order No.		Dimension		Keying Required at Circuit Positions						Middle Locking Peg
	Natural	Black	A	B	1	2	3	4	5	6	
6	90331-X001	90331-X101	23.67 ± 0.13	19.81 ± 0.13	Yes	Yes	Yes	Yes	Yes	Yes	Yes
6	90331-X002	90331-X102	23.67 ± 0.13	19.81 ± 0.13	Yes	No	No	No	No	No	Yes
6	90331-X003	90331-X103	23.67 ± 0.13	19.81 ± 0.13	No	No	No	Yes	No	No	Yes
6	90331-X007	90331-X107	23.67 ± 0.13	19.81 ± 0.13	No	Yes	No	No	No	No	Yes
6	90331-X008	90331-X108	23.67 ± 0.13	19.81 ± 0.13	No	No	Yes	No	No	No	Yes
6	90331-X009	90331-X109	23.67 ± 0.13	19.81 ± 0.13	No	No	No	No	Yes	No	Yes
6	90331-X010	90331-X110	23.67 ± 0.13	19.81 ± 0.13	No	No	No	No	No	Yes	Yes

Terminal	
Chain	08-50-0277
Loose	08-50-0276

Material: Replace X with
 0 = Polyester, UL 94V-0
 1 = 6/6 nylon, UL 94V-0
 4 = 6/6 nylon, UL 94V-2